

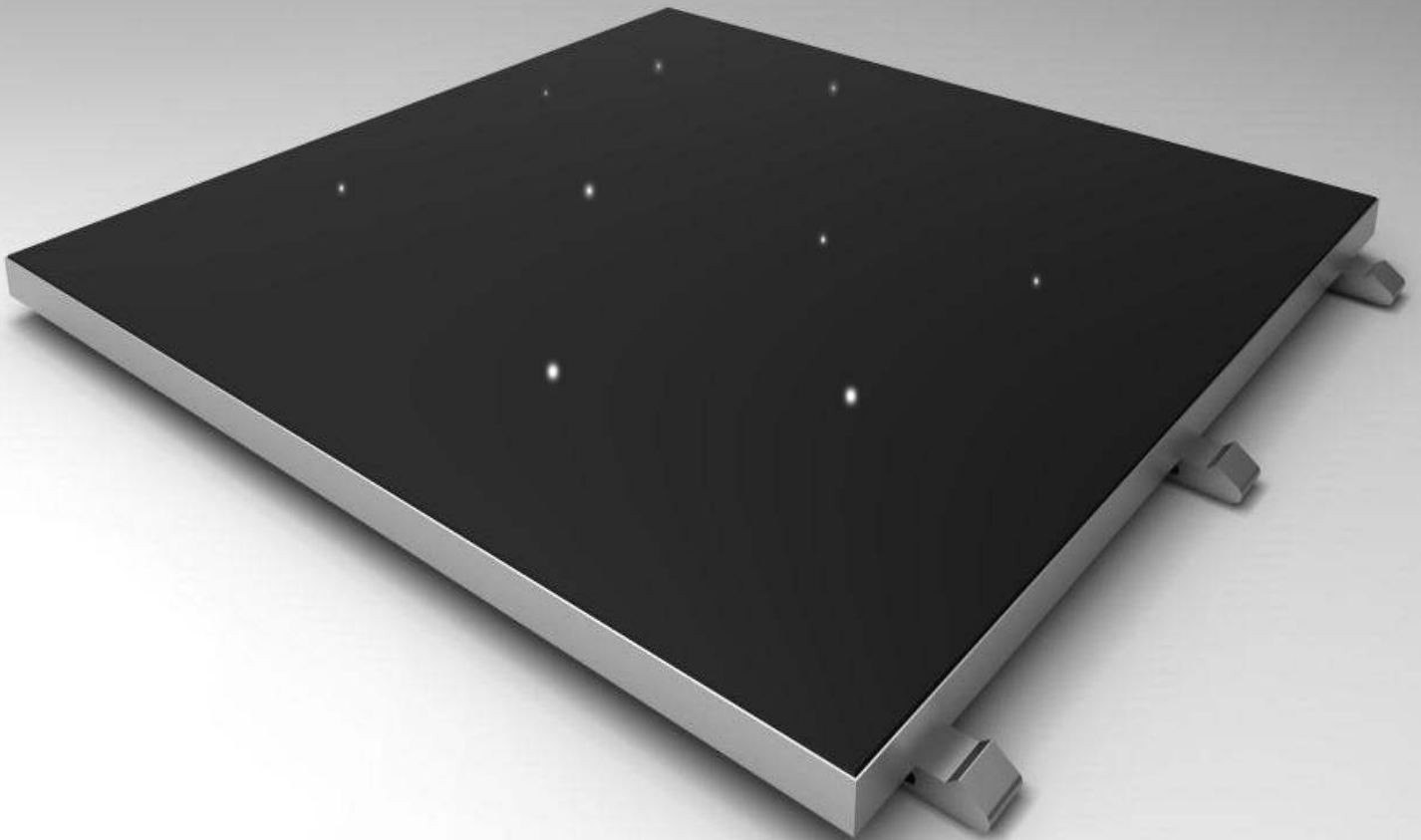

# LIT ACRYLIC DANCE FLOOR



## INSTRUCTION MANUAL

A Step by Step Guide on Assembling Your Floor

# LIT FLOORING SYSTEM – USER GUIDE

Thank you for purchasing Burgess Furniture’s Lit Flooring System. Please read carefully through all the provided material before laying your floor

<b>Contents</b>	<b>Page</b>
Laying Instructions.....	2-4
Floor Design and specifications.....	5-7
Component list .....	8
Maintenance .....	9
Trouble shooting.....	10
Warranty.....	11

## LIT FLOORING SYSTEM – LAYING INSTRUCTIONS

### STEP 1

Start at the top left hand corner position by placing a full panel with the 2 end lugs pointing to the left. Then lay a second panel with the two end lugs pointing to the right. Add the next panel and so on for the size of floor length required.

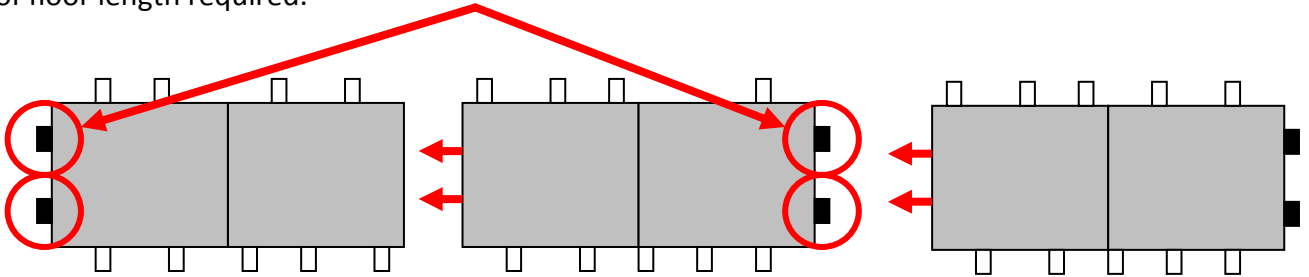

### STEP 2

After completing the first row, fit the edging along the length. The edging lays in the same way as the floor panels (See **diagram 1**; page 3) and acts as a “straight edge” ensuring each row is square and flush as it is laid (ideally no gaps).

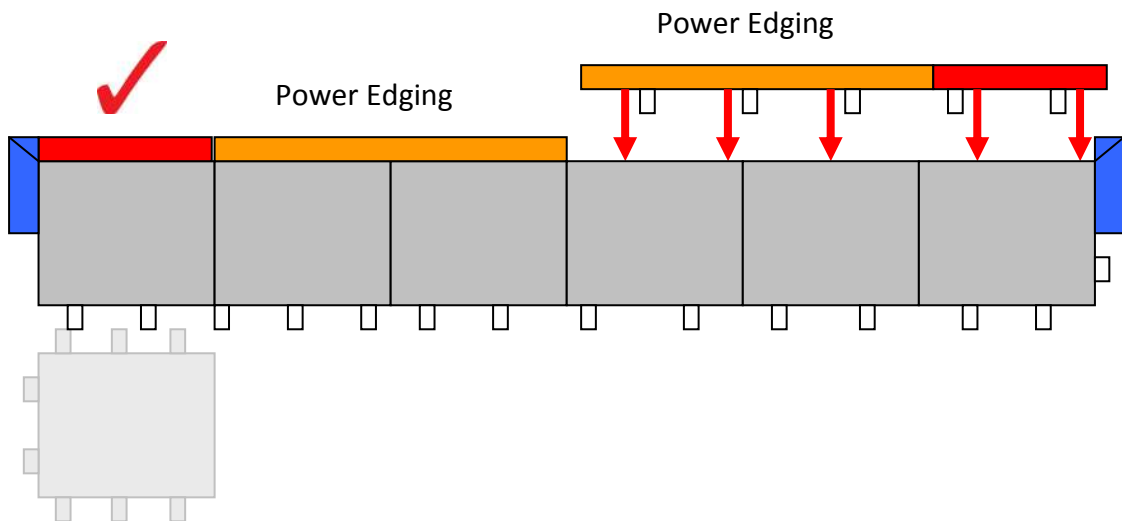

At this stage, you could put your power edge on (See pages 5, 6, 7 for more instructions)



*The top row of edging should mirror the second row of panels, to stagger the joints and support the panel corners.*

*The edging row starts with a half edge (2ft long) then 2 full (4ft long) edges, and finishes with a half edge.*

## LIT FLOORING SYSTEM – LAYING INSTRUCTIONS

Half length (illustrated in red) and full length edges (illustrated in green) are supplied so the panel joints and the edging joints never coincide i.e. they follow the same brickwork pattern. Each floor will require 2 left corner edging pieces and 2 right corner edging pieces (Illustrated in blue) which always go along the row ends.

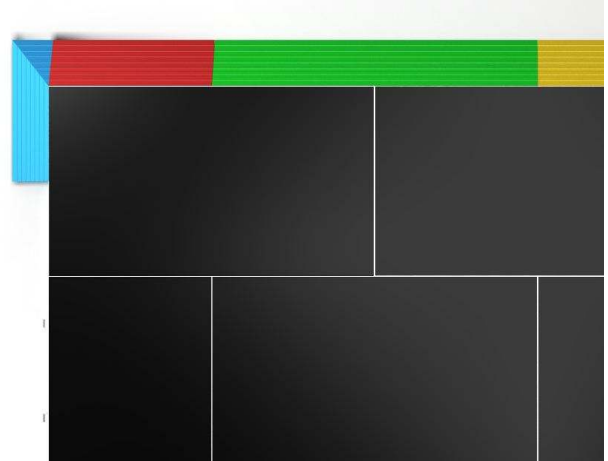
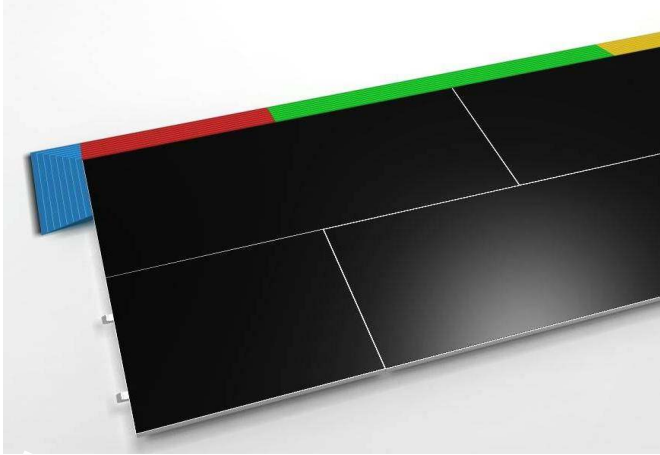

*It may-be helpful to have someone apply some weight to the first row when connecting the edging and when creating the second row to stop the floor sliding.*

### To fit the edging or floor panels

Hold the panel or edging at an angle as in **diagram 1** below and push so the lugs slide under the panel. Lower the panel or edging whilst continuing the push, the lugs will connect the panels or edging and should sit flush with each other.

**DO NOT FORCE THE PANELS or EDGING DOWN** – simply adjust until they fit.

Continue to lay the row or edging in this manner. When connecting the floor panels together, use as many full panels as required for the size of the floor, be aware, the floor design can end in a half panel. The edging will be supplied to meet your floor size and will be a mixture of full and half lengths as well as the corners

**Diagram 1:**  
Connecting the floor panels

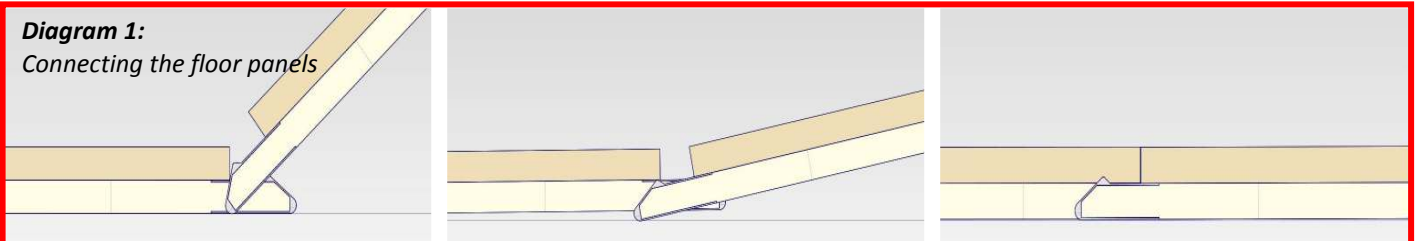

## LIT FLOORING SYSTEM – LAYING INSTRUCTIONS

### STEP 3

#### Second Row:

With the two end lugs pointing to the left as you look at the floor **begin the second row with a half panel**. Next lay full panels along the row; you should now have two end lugs pointing to the right from the second panel onwards. End the row with another half panel if required. Continue to lay alternate rows in this manner for the size of the floor.

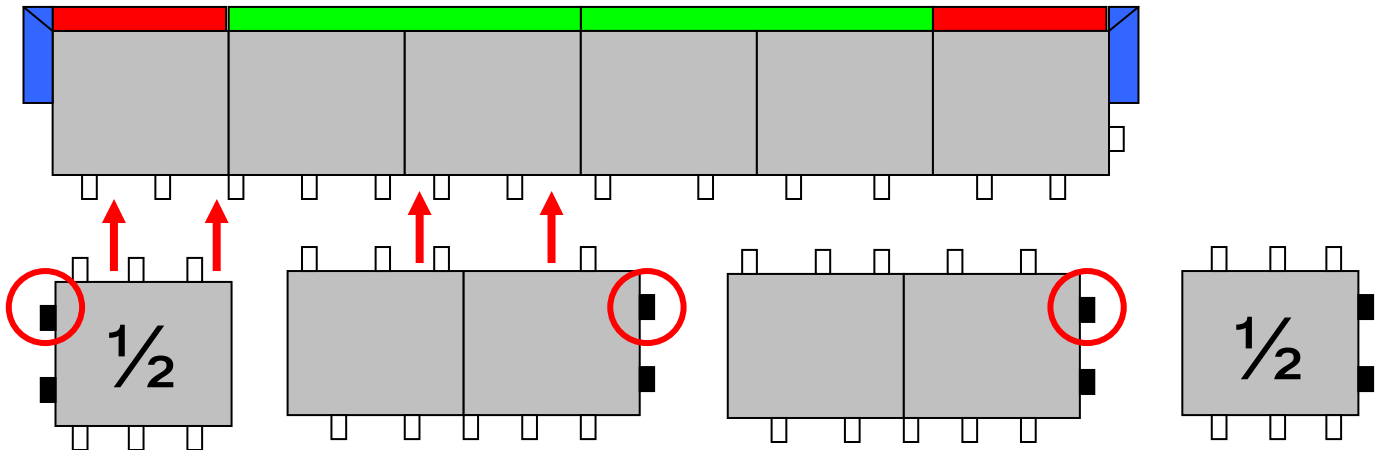

#### The Power Connectors:

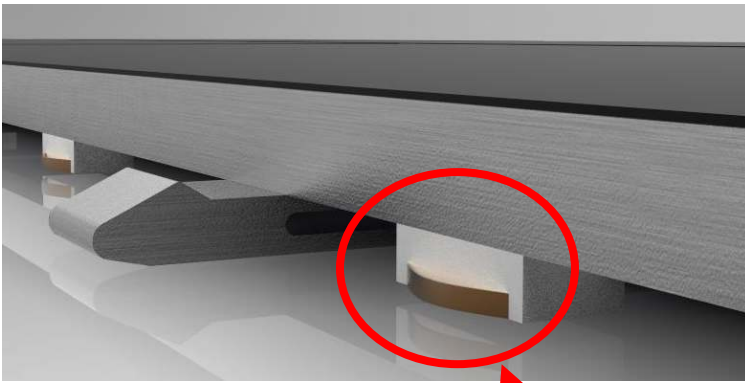

*It's a good idea to lay the floor with the power on so that if a fault develops, you will be able to see which panel has a poor connection.*

Power travels through the floor via integrated connectors. Each panel has multiple connectors allowing the floor to be laid in any configuration. When laying the floor, please be careful and inspect the connectors for signs of wear and damage, ensuring to keep the contacts clean. A power edge can go on the top or bottom edge of the floor as shown on pages 5, 6, 7.



*Still having difficulty with your floor? See our trouble shooting guide on page 10 to help resolve any common problems you may have when laying the floor*

# LIT FLOORING SYSTEM – FLOOR DESIGN

At Grumpy Joe's we suggest when designing the floor and deciding how many panels you want, you always start with the long-side first. For example a 6ft x 8ft floor, you design it to an 8ft x 6ft as shown below:



Recommended design planning

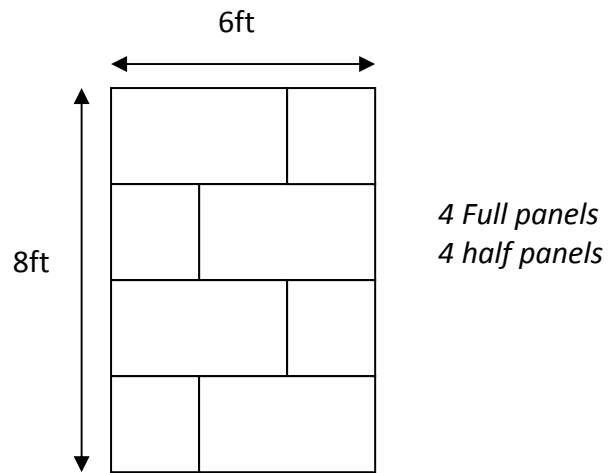
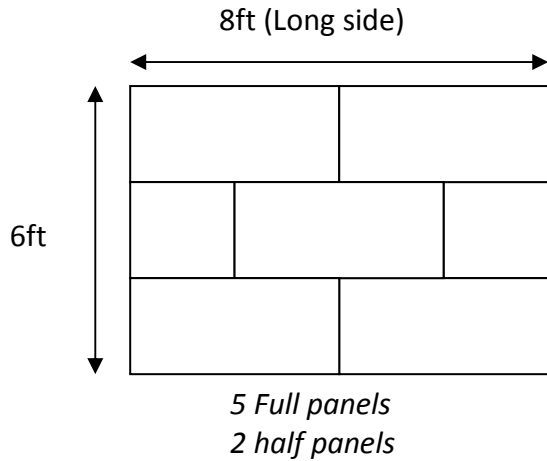

By designing the floor the long-side first, you use less half panels yet the floor is the same size 24ft<sup>2</sup>.

The power edging will always be a 4ft length so on the above design, the power edging could be fixed as shown below: Remember, you only need 1 power edge, the diagrams below just indicate where it could be fixed.

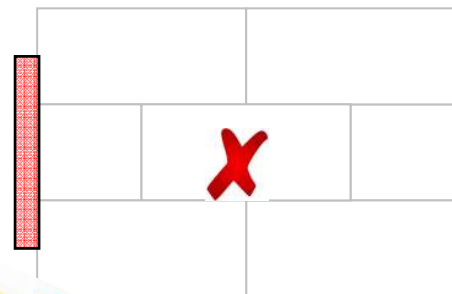
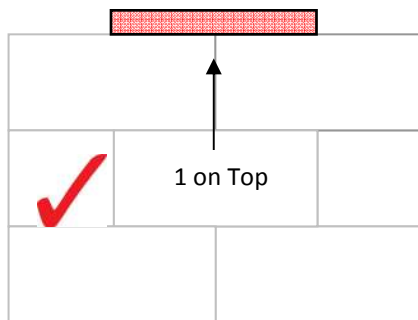

Do not put a power edge on the short side, it will not work

Any of these combinations will power the floor

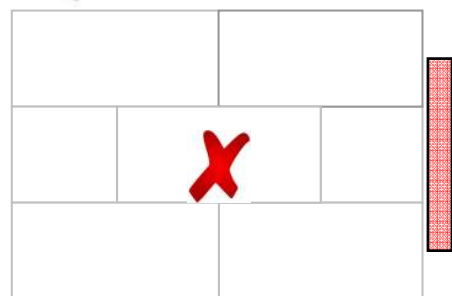
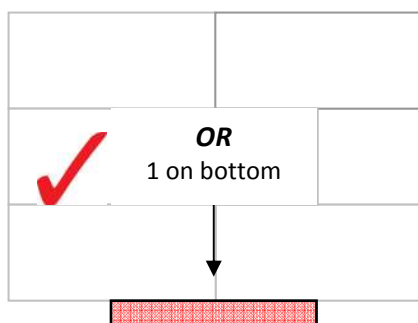

## LIT FLOORING SYSTEM – FLOOR DESIGN

With a 8ft x 6ft floor and with the power supply attached, the flow of power is as shown below:

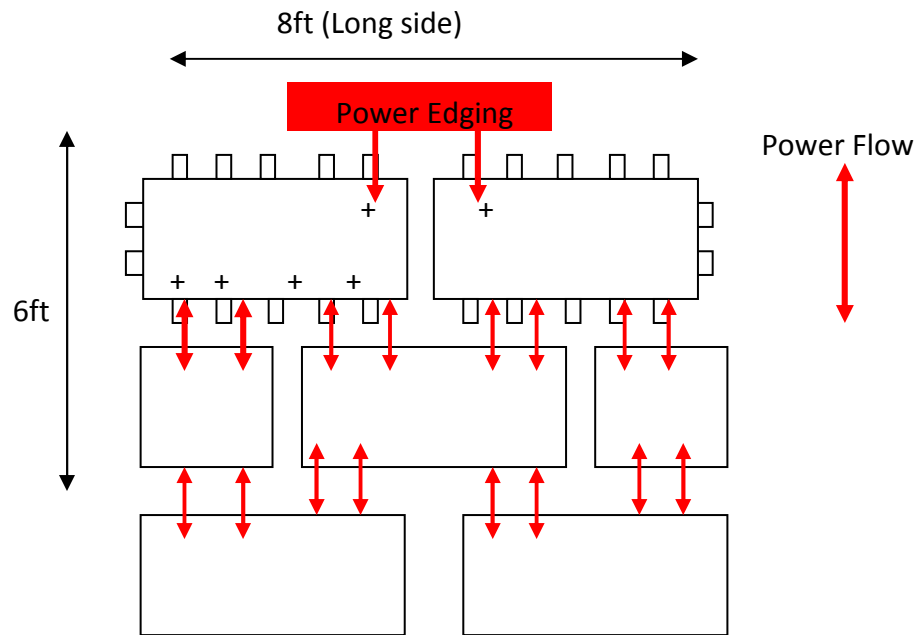

Regardless of most sizes, this power flow principle applies. This system therefore ensures that power flows to all the floor panels even if one panel is not receiving the power as it should for some reason (See trouble shooting guide if you are experiencing trouble with your floor)

### Power supply

*DESIGNED FOR INDOOR USE*

*DO NOT OBSTRUCT HEAT VENTILATION SLOTS*

*DO NOT ATTEMPT REPAIR*

Input Voltage : 110-240 VAC 50Hz max.

Output Voltage : 36 VDC (9A max.)

### Floor Panels

*DESIGNED FOR INDOOR USE*

Input Voltage/Current: 36 VDC / 9A

Power Consumption : 0.1A per panel

A single power supply will power up to a 24ft x 24ft floor. If you are laying a larger floor, you will require additional power supplies. Call to discuss your power requirements with one of our technical team.

# LIT FLOORING SYSTEM – FLOOR DESIGN

## A 14 x 14 Floor

Power Edging – A power edge can go in any of the shown position(s) and replace a full edge.

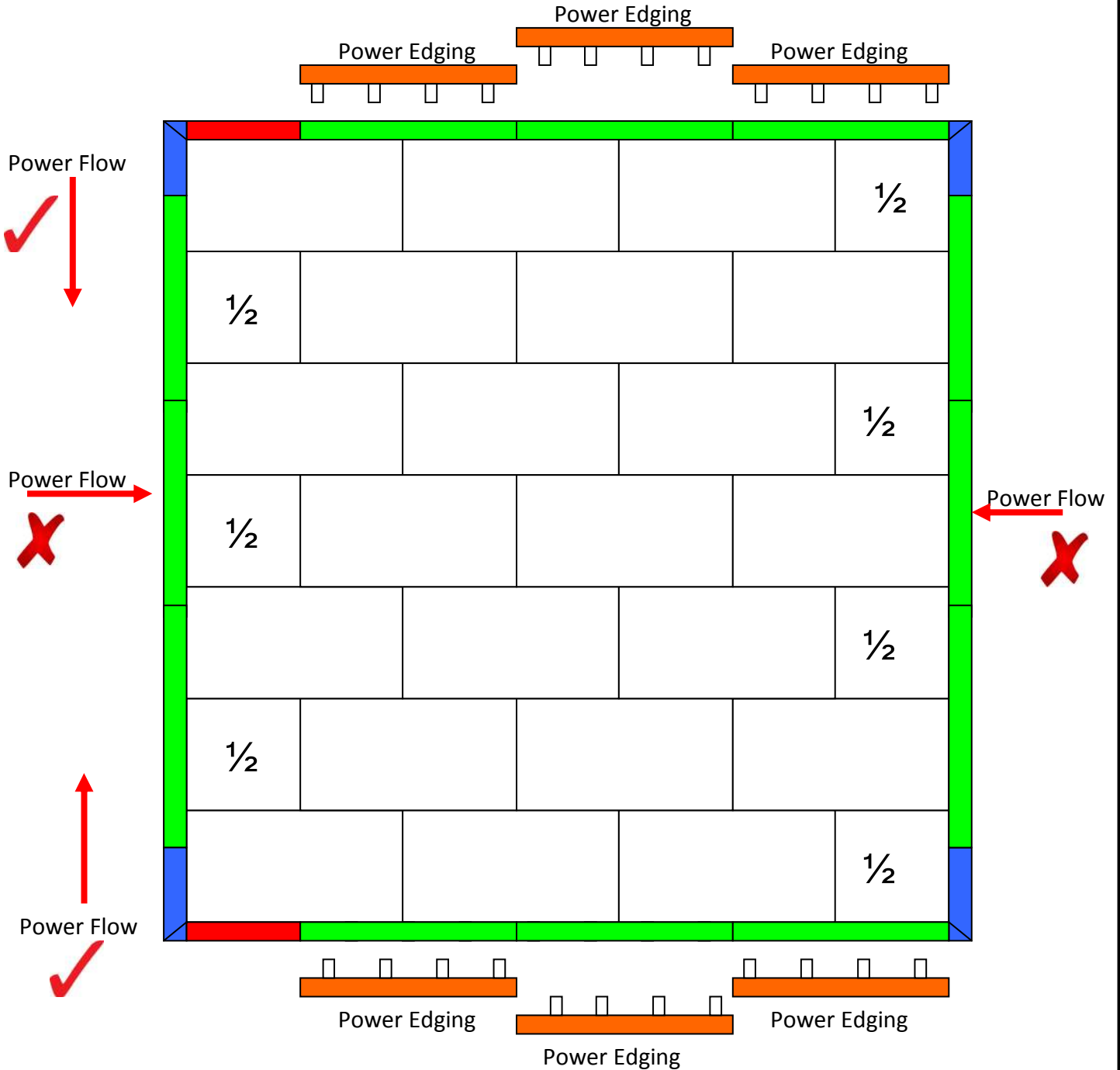



## LIT FLOORING SYSTEM – OPERATION

Once the floor has been set up to the desired size and powered up, the floor starts in a slow twinkle pattern (This is the default setting).

The remote control supplied with the floor will allow you to alter the twinkle pattern of the floor LED's.

The remote has the following functions:

- All lights on (START)
- All lights off (STOP)
- Speed twinkle up (FAST)
- Slow twinkle down (SLOW)

*There are 6 speed settings in total*

### Remote Control Function Buttons

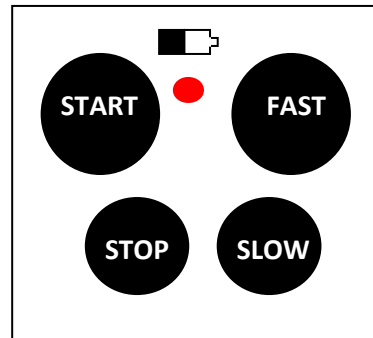

### Remote Operation



Pressing this function button will switch the floor lights on



Pressing this function button will switch the floor lights off



Pressing this function button will increase the speed of the twinkle effect



Pressing this function button will decrease the speed of the twinkle effect



On each press of the function button(s), the remote will beep a single tone to acknowledge the button press and the light will flash once; it will then beep again to acknowledge the floor has received the command and the light will flash again.

If only one beep sounds, this implies the floor has not picked up the signal from the remote and the batteries may require changing or, you are out of range for the floor to pick up the signal.

The remote requires 2 x AAA

## LIT FLOORING SYSTEM – COMPONENTS LIST

### Component List (Working on the “long-side” design principle)

Floor size	Full panel	Half panel	Powered edge	Full edge	Half edge	R/L corner
8ft x 8ft	6	4	1	4	4	4
10ft x 10ft	10	5	1	7	2	4
12ft x 10ft	13	4	1	7	4	4
12ft x 12ft	15	6	1	8	4	4
14ft x 12ft	18	6	1	9	4	4
14ft x 14ft	21	7	1	11	2	4
16ft x 14ft	25	6	1	12	4	4
18ft x 14ft	28	7	1	13	2	4
16ft x 16ft	28	8	1	12	4	4
18ft x 16ft	32	8	1	14	2	4
20ft x 16ft	36	8	1	14	4	4
18ft x 18ft	36	9	1	15	2	4
20ft x 18ft	41	8	1	15	4	4
20ft x 20ft	45	10	1	16	4	4
22ft x 20ft	50	10	1	18	2	4
22ft x 22ft	55	11	1	19	2	4
24ft x 22ft	61	10	1	20	3	4
24ft x 24ft	66	12	1	21	3	4

### Component Specifications

	Dimensions (cm)	Dimensions (inches)	Weight (kg)	Weight (lb)
Full panel	125 x 67.5 x 3	49.2 x 26.6 x 1.2	13	26.5
Half panel	67.5 x 64.5 x 3	26.6 x 25.4 x 1.2	7	13.2
Power Edge	122 x 16.2 x 3	48 x 5 x 1.2	2	4.5
Full edge	122 x 16.2 x 3	48 x 5 x 1.2	2	4.5
Half edge	61 x 16.2 x 3	24 x 5 x 1.2	1	2.2
R/L corners	43.5 x 16.2 x 3	14.9 x 5 x 1.2	1	2.2
Trolley	140 x 67 x 151	55.25 x 26.25 x 51.25	43	95
Full trolley (16ft x 16ft floor)	140 x 67 x 151	55.25 x 26.25 x 51.25	435	959

## LIT FLOORING SYSTEM – PRODUCT SAFETY and MAINTENANCE

The design of our Lit Flooring System delivers excellent durability, reliability and performance. We expect the floor may come in to contact with minor spillages such as from drinks, the floor is durable enough to withstand such incidences and ideally would be cleaned up straight away. As with all our products, we recommend regular cleaning and inspection schedules to be followed to ensure the continued functionality of your product.



### Product Care and Maintenance

**THIS PRODUCT SHOULD BE LAID ON A LEVEL, DRY, SOLID SURFACE.**

- It must not be used in \*extreme temperatures as the acrylic will expand and contract.
- Clean with a damp cloth, mild detergent or acrylic cleaner – we recommend an Acrylic Potion.
- Should the floor get wet, immediately remove all liquid and dry thoroughly.
- Ensure all contacts are clean and straight before laying.
- Keep contacts clean if necessary with wire wool or fine sandpaper.
- Store in the appropriate trolley or on a flat secure surface.
- If cleaning with a mop, DO NOT clean with a wet mop, it should be damp.
- Store face-to-face and back to back when stacked.
- DO NOT use abrasive cleaners.

*\*Extreme temperatures include, but not limited to, the cold, heat such as; direct sunlight or close to high powered theatre type lights.*



### PRODUCT SAFETY

- Immediately remove any liquid and dry thoroughly as the floor can be slippery when wet.
- Always ensure any panel edges or edging product is not protruding to cause a trip hazard.
- When using the dance floor, always wear appropriate footwear.
- Floor parts should be checked regularly, any foreign or metallic objects removed immediately.
- Always use appropriate lifting procedures and work wear when handling, fitting or moving the product.

*For further safety information, please ask for our risk assessment sheet.*

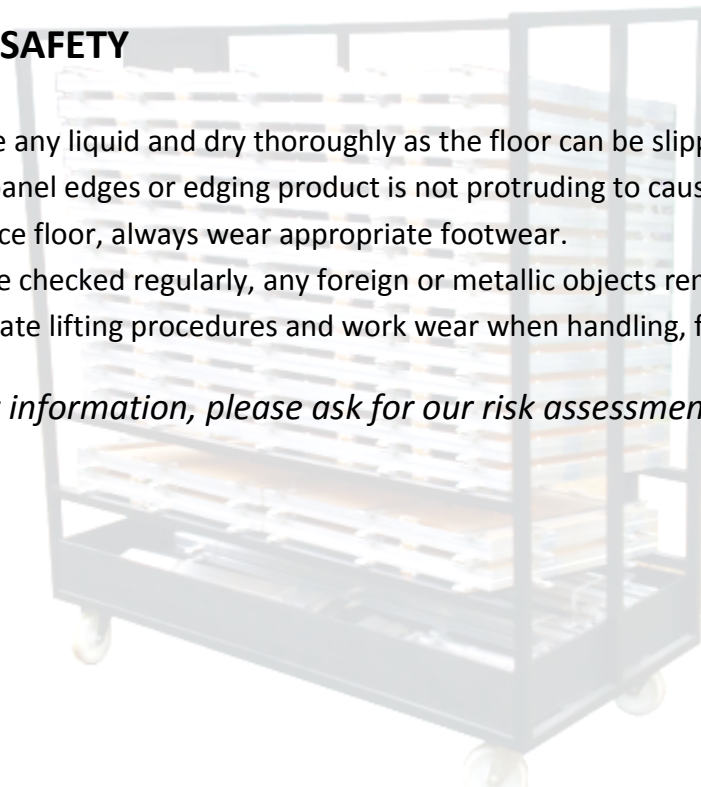

## LIT FLOORING SYSTEM – TROUBLE SHOOTING

### Trouble shooting

Problem	Suggestion
Floor does not light up when all connected	Ensure the powered edge is on top of the floor and not on the ends of the rows. The connectors on the power edge <b>MUST</b> line up with the connectors on the sides of the panels for the system to work
No Power to the floor	Ensure there is power to your power supply and that the red LED on the front of the power supply is illuminated
Power light on but no floor power	If the power LED is dimly lit then unplug the supply from the floor and ensure the power light comes on at full brightness, re-plug the floor back into the power supply.
Still no power despite following above trouble shooting	The power supply has a built in short circuit protection. If there is a short circuit on your floor, the power LED on the power supply will go out or become dimly lit. If this happens, lift the floor panels until the fault clears, remove and clean the offending panel
Floor was working but has no power when adding floor panels	A single power supply will power up to a 24ft x 24ft floor. If you are laying a larger floor, you will require additional power supplies.

# LIT FLOORING SYSTEM – TERMS and CONDITIONS

Warranty for "twinkling" LED Lit Flooring: 1 year  
 Limited warranty for electronic components  
 3 years Limited Warranty for interlocking system

For the warranty period indicated above, the Manufacturer warrants to the Purchaser (Owner) that the Manufacturer will, subject to the Terms, Conditions, and Limitations set forth below, provide repair work or replacement "twinkling" LED Lit Flooring panels or LED Lit Flooring electronic components or the option of a prorated credit (based upon the remaining months of the unexpired warranty) sufficient to replace any area of Lit Flooring as a result of any manufacturing defect in the floor electronics or interlocking system subject to exclusions (4) below to include all transport costs in the UK mainland only (Not including Northern Ireland). Our repair obligation over the life of this warranty is limited to the owner's original cost of the Lit Flooring. All other repairs to be returned to the manufacturer at the owner's expense and the manufacturer will repair or replace at the owners expense subject to notice and investigation (2) set out below. The manufacturer warrants that the goods will be of satisfactory quality at the time of purchase and or delivery and the Manufacturer shall at its option refund the purchase price or replace free of charge any goods which are defective provided; (a) the owner makes a full inspection of the goods immediately upon delivery to include third party carriers delivery (b) Any delivery by a third party carrier has been checked thoroughly and the owner does not sign for damaged flooring (c) the owner notifies the manufacturer as laid out in notice and investigations 2(a) below.

## TERMS, CONDITIONS, AND LIMITATIONS

**1. Products Covered:** The twinkling LED Lit Flooring is limited to mean the Manufacturer's Twinkling LED Lit Flooring when installed, maintained and stored in accordance with Manufacturer's Current Technical Specifications.

**2. Notice & Investigation:** In the event that a potential claim is suspected due to defective goods at time of delivery, electronic failure or interlocking system failure that would be covered by this warranty: (a) The Purchaser must give notice to the Manufacturer through e-mail, telephone call or in writing within **fourteen (14)** days of the discovery of a potential claim along with a copy of the purchase invoice and (if possible or appropriate) a sample picture of the defective panel from the twinkling LED Lit Flooring. By so notifying the Manufacturer, the Purchaser authorises the Manufacturer or its designee to investigate the claim. (b) If upon investigation, the Manufacturer determines that the fault is not excluded under the Terms, Conditions and Limitations set forth and is the result of less than expected Manufacturers floor performance or a manufacturing defect in the flooring at the time of manufacture, the Owner's sole and exclusive remedy and the Manufacturer's liability will be limited to providing repaired original or replacement flooring (or a prorated credit). (c) Should the investigation reveal that the damage is excluded under the Terms, Conditions, and Limitations set forth below, the Owner is responsible for payment of the investigation costs. Failure by Owner to pay for these costs shall render the twinkling LED Lit Flooring Product the property of the manufacturer until such time all payments are settled. The Manufacturer will advise the Owner of the type and/or extent of repairs required to be made at the Owner's expense that will permit this Limited Warranty to remain in effect for the unexpired portion of its term. Failure by the Owner to properly notify the manufacturer of the repair needs in a reasonable manner and within a reasonable time shall render this Limited Warranty null and void. (d) Any dispute, controversy or claim between the Owner and the Manufacturer concerning this Limited Warranty shall be settled by mediation. In the event that the Owner and the Manufacturer do not resolve the dispute, controversy or claim in mediation, the Owner and the Manufacturer agree that neither party will commence or prosecute any suit, proceeding or claim other than in the English courts governed by English Law. Each party irrevocably consents to the jurisdiction and venue of the identified English court as Nottingham County Court, 60 Canal Street, Nottingham, NG1 7EJ

**3. Payment Required:** The Manufacturer shall have no obligation under this Limited Warranty unless and until the Manufacturer has been paid in full for all materials, supplies, services, warranty costs and other costs which are included in, or incidental to, the twinkling LED Lit Flooring and, or including, the interlocking system.

**4. Exclusions:** The Manufacturer shall have no obligation under this Limited Warranty, or any other liability, now or in the future if damage to the floor and its parts or surrounding environment is caused by: (a) Natural forces, disasters, accidents or incidents including, but not limited to, wind, hurricanes, tornadoes, hail, lightning, earthquakes, atomic radiation, insects, or animals; (b) Any act(s), conduct or omission(s) by any person, or act(s) of war, which damages the twinkling LED Lit Flooring or which impairs the twinkling LED Lit Flooring; (c) Failure by the Owner to use reasonable care in maintaining the Twinkling LED Lit Flooring, said maintenance to include, but not limited to those items listed in the Lit Flooring Instruction manual titled "Lit Flooring System – Product Safety and Maintenance" (d) Condensation or excessive infiltration of moisture in, through, or around the flooring panels or electronics equipment; (e) Excessive heat directly or indirectly to include but not limited to Theatre lights, direct sunlight, fire; (f) Excessive wear and tear beyond normal tolerances of the Manufacturers expectation of flooring performance; (g) Any acid, oil, harmful chemical, chemical or physical reaction and the like which comes in contact with the twinkling LED Lit Flooring; (h) Power surges, connections to improper voltage supply or foreign objects which cause, but not limited to shorting or excess heat build-up which damage the panels electronics, parts or surrounding environment; (i) Alterations or repairs to the twinkling LED Lit Flooring not approved in writing by the Manufacturers' authorised person(s); (j) A change in use or purpose; (k) Poor or improper installation; (L) Use of the product inconsistent with the safety standards in force in the country where it is used and product safety recommendations as written in the manufacturers instructions manual; (m) Damage to the product components or laying surface caused by accidents including but not limited to exclusion 4(k) and misuse or neglect; (n) Failure to give proper notice as set forth in paragraph 2(a) above; (o) Carriers damage to include signed paperwork by the Owner of the floor that has not been checked thoroughly for damage in transit as, signed delivery of the flooring by the Owner deems the floor in a satisfactory condition at the point of delivery making any application by the Manufacturer on the Owners behalf against the carrier null and void and as such, no claim by the Owner as set forth in section (2) Notice & Investigation above can be made.

**5. Exceptions:** In no event shall The Manufacturer be liable for personal injury or death, incidental or consequential to include, but not limited to the public and/or the buyer/Owner.

**6. Waiver:** The Manufacturer's failure to enforce any of the terms or conditions stated herein shall not be construed as a waiver of such provision or of any other terms and conditions of this Limited Warranty and shall no way affect the manufacturers right to enforce provision at a later date.

**7. Limits:** This Limited Warranty does not cover the twinkling LED Lit Floor Acrylic Surface to include loss of the surface gloss finish. The surface of the dance floor is a tough solid acrylic. This can be scratched by, but not limited to grit, sand, stones or broken glass being ground into the surface. Scratches or damage to the surface of the acrylic are not covered by this Limited Warranty and care should be taken to protect the surface as explained in the users manual.

THE MANUFACTURER DOES NOT WARRANT PRODUCTS INCORPORATED OR UTILISED IN ANY INSTALLATION THAT IT HAS NOT FURNISHED. THE MANUFACTURER SPECIFICALLY DISCLAIMS LIABILITY, UNDER ANY THEORY OF LAW, ARISING OUT OF THE INSTALLATION OR PERFORMANCE OF, OR DAMAGES SUSTAINED BY OR CAUSED BY, PRODUCTS NOT FURNISHED BY THE MANUFACTURER. THIS LIMITED WARRANTY SUPERSEDES AND IS IN LIEU OF ALL OTHER WARRANTIES OR GUARANTEES WHETHER WRITTEN OR ORAL, EXPRESS OR IMPLIED, INCLUDING, WITHOUT LIMITATION, WARRANTIES OF MERCHANTABILITY AND FITNESS FOR A PARTICULAR PURPOSE. THIS LIMITED WARRANTY SHALL BE THE OWNER'S SOLE AND EXCLUSIVE REMEDY AGAINST THE MANUFACTURER AND THE MANUFACTURER SHALL NOT BE LIABLE FOR ANY CONSEQUENTIAL, SPECIAL, INCIDENTAL OR OTHER DAMAGES INCLUDING, BUT NOT LIMITED TO, LOSS OF PROFITS. THIS LIMITED WARRANTY CANNOT BE AMENDED, ALTERED OR MODIFIED IN ANY WAY EXCEPT IN WRITING SIGNED BY AN AUTHORISED OFFICER OF THE MANUFACTURER. NO OTHER PERSON HAS ANY AUTHORITY TO BIND THE MANUFACTURER WITH ANY REPRESENTATION OR WARRANTY WHETHER ORAL OR WRITTEN.